



meccanocar

User manual

4770007370

Adattabile per OPEL 1.6
diesel (B16)

Adaptable pour OPEL 1.6 diesel (B16) **FR**

Suitable for OPEL 1.6 diesel engines (B16) **EN**

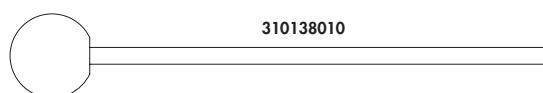
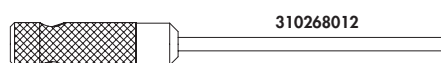
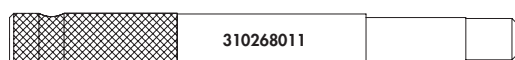
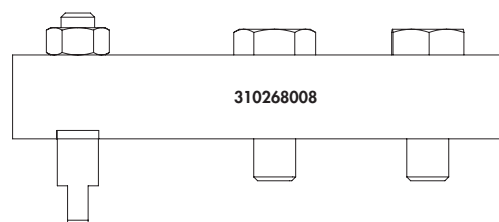
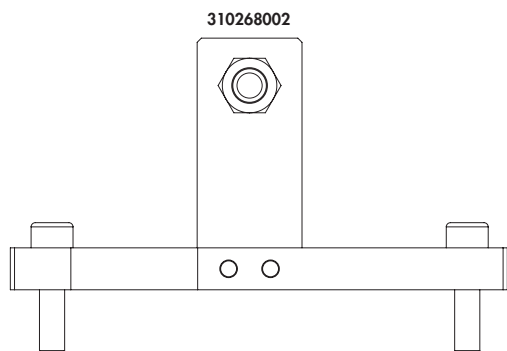

Componenti

310268002	EN-51188	ATTREZZO DI BLOCCAGGIO PIGNONE ALBERO A CAMME CON ELEMENTI DI FISSAGGIO	
310268012	EN-50513	PERNO TENDICINGHIA	
310268008	EN-51140	ATTREZZO DI ALLINEAMENTO ALBERO A CAMME CON ELEMENTI DI FISSAGGIO	
310268011	EN-51143	PERNO DI BLOCCAGGIO ALBERO A CAMME	
310138010	EN-6349 – EN-6130	PERNO DI BLOCCAGGIO ALBERO DI BILANCIAMENTO	

PRECAUZIONI SPECIALI - LEGGERE ATTENTAMENTE

- **Utilizzare guanti antinfortunistici, scarpe antinfortunistiche, elmetto e occhiali di protezione**

- **Uso improprio:**

Il prodotto deve essere destinato solo ed esclusivamente all'uso descritto in questa documentazione, ogni altro uso è da considerarsi improprio.

Il produttore declina ogni responsabilità per possibili danni causati da usi errati o irragionevoli dell'attrezzatura;

L'uso improprio invalida inoltre la garanzia.

- **Tenere gli attrezzi con cura:**

Conservare sempre gli attrezzi puliti.

Riporre gli attrezzi all'interno della confezione originale.

- Scollegare il cavo della batteria dal polo negativo di terra (verificare il codice radio se disponibile)
- Rimuovere le candele o le candele per facilitare la rotazione del motore
- Non utilizzare detersivi liquidi su cinghie, pignoni o tensionatori
- Segnare il senso di rotazione della cinghia ausiliaria prima di rimuoverla
- Ruotare il motore in senso orario (antiorario solo se specificato)

- Non ruotare mai l'albero a camme, l'albero motore o la pompa d'iniezione diesel quando la catena è già stata rimossa (a meno che non sia specificato)
- Non utilizzare la catena di distribuzione per bloccare il motore quando si allentano o si stringono i bulloni della puleggia dell'albero motore
- Non ruotare l'albero motore o l'albero a camme quando la cinghia/catena è già stata rimossa
- Prima di rimuovere la catena, segnare la sua direzione
- È sempre consigliato ruotare il motore lentamente manualmente e riverificare il posizionamento dell'albero motore e dell'albero a camme
- Gli alberi a camme e motore possono essere ruotati solamente quando il meccanismo di azionamento della catena/cinghia è completamente installato.
- Non ruotare il motore azionando l'albero a camme o altri ingranaggi
- Verificare la corretta posizione della pompa d'iniezione diesel dopo aver sostituito la catena
- Osservare tutte le coppie di serraggio
- Attenersi sempre al manuale della casa costruttrice o al libretto d'istruzioni fornito
- Una fasatura del motore non precisa o sbagliata comporta il danneggiamento delle valvole



APPLICAZIONI

OPEL	Astra-J	1.6 CDTi ecoFLEX	LVL/B16DTH	2013 - 2017
	Astra-J	1.6 CDTi ecoFLEX	LVL/B16DTH	2013 - 2017
	Astra-J	1.6 CDTi ecoFLEX	LVM/B16DTL	2013 - 2017
	Astra-K	1.6 CDTi	LVL/B16DTH	2015 - 2017
	Astra-K	1.6 CDTi	LWQ/B16DTC	2015 - 2017
	Astra-K	1.6 CDTi	LWQ/B16DTE	2015 - 2017
	GTC	1.6 CDTi ecoFLEX	LVL/B16DTH	2015 - 2017
	GTC	1.6 CDTi ecoFLEX	LVL/B16DTH	2015 - 2017
	Insignia	1.6 CDTi	LVL/B16DTH	2015 - 2017
	Insignia	1.6 CDTi	LVL/B16DTJ	2015 - 2017
	Meriva-B	1.6 CDTi	LVL/B16DTH	2013 - 2017
	Meriva-B	1.6 CDTi	LVL/B16DTN	2013 - 2017

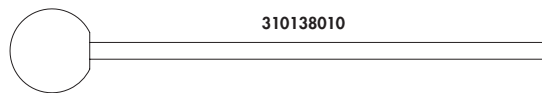
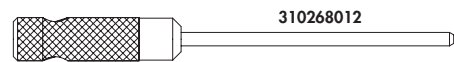
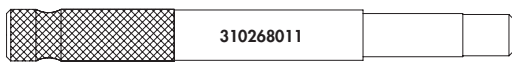
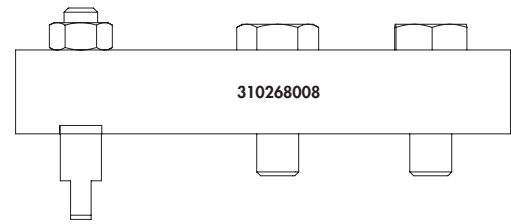
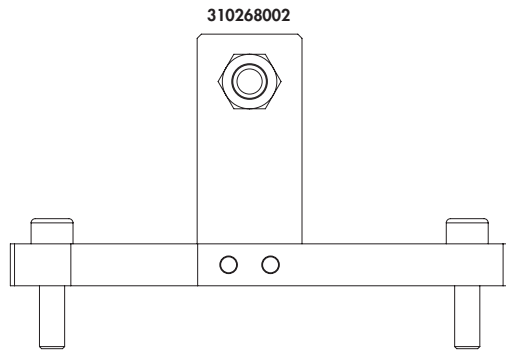
Codice motore	Codice OEM				
	EN-51188	EN-50513	EN-51140	EN-51143	EN-6349 – EN-6130
LVL/B16DTH	•	•	•	•	•
LVM/B16DTL	•	•	•	•	•
LVL/B16DTH	•	•	•	•	•
LWQ/B16DTC	•	•	•	•	•
LWQ/B16DTE	•	•	•	•	•
LVL/B16DTJ	•	•	•	•	•
LVL/B16DTN	•	•	•	•	•
LVM/B16DTC	•	•	•	•	•
LVM/B16DTL	•	•	•	•	•
LWQ/B16DTE	•	•	•	•	•
LVL/B16DTN	•	•	•	•	•
LVL/B16DTJ	•	•	•	•	•

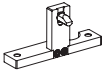

Composants

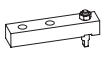
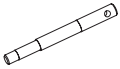
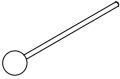
310268002	EN-51188	HERRAMIENTA DE BLOQUEO PIÑÓN ÁRBOL DE LEVAS CON ELEMENTOS DE FIJACIÓN	
310268012	EN-50513	PERNO TENSOR DE CORREA	
310268008	EN-51140	HERRAMIENTA DE ALINEACIÓN ÁRBOL DE LEVAS CON ELEMENTOS DE FIJACIÓN	
310268011	EN-51143	PERNO DE BLOQUEO ÁRBOL DE LEVAS	
310138010	EN-6349 – EN-6130	PERNO DE BLOQUEO EJE DE EQUILIBRIO	

PRÉCAUTIONS SPÉCIALES - LIRE ATTENTIVEMENT

- **Utiliser des gants anti-accident, des chaussures anti-accident, un casque de protection et des lunettes de protection**

- **Usage impropre:**

Le produit ne doit être utilisé que pour l'usage prévu dans la présente documentation. Tout autre usage doit être considéré comme impropre.

Le producteur décline toute responsabilité pour tout dommage découlant d'usages erronés ou irraisonnables de l'équipement.

L'usage impropre annule la garantie.

- **Prendre bien soin des outils:**

Toujours garder les outils bien propres.

Ranger les outils dans leur emballage d'origine.

- Débrancher le câble de la batterie du pôle négatif de terre (vérifier le code radio si disponible)
- Enlever les bougies afin de faciliter la rotation du moteur
- Ne pas utiliser de détergents liquides sur les courroies, les pignons et les tensionneurs
- Indiquer le sens de rotation de la courroie auxiliaire avant de l'enlever
- Faire tourner le moteur dans le sens des aiguilles d'une montre (contraire seulement si spécifié)
- Ne jamais faire tourner l'arbre à cames, l'arbre moteur ou la pompe d'injection diesel lorsque la chaîne a déjà

été enlevé (à moins que ce soit spécifié)

- Ne pas utiliser la chaîne de distribution pour bloquer le moteur quand les boulons de la poulie de l'arbre moteur se serrent ou se desserrent
- Ne pas faire tourner l'arbre moteur ou l'arbre à came lorsque la courroie/chaîne a déjà été enlevée
- Avant d'enlever la chaîne, indiquer sa direction
- Il est toujours conseillé de faire tourner lentement le moteur de façon manuelle et de vérifier le positionnement de l'arbre moteur et de l'arbre à cames.
- Les arbres à cames et moteur peuvent être tournée seulement lorsque le mécanisme d'actionnement de la chaîne/courroie est complètement installé.
- Ne pas faire tourner le moteur en actionnant l'arbre à cames ou d'autres engrenages
- Vérifier la position correcte de la pompe d'injection diesel après avoir remplacé la chaîne
- Observer tous les couples de serrage
- Toujours se reporter au manuel de maison constructrice ou au mode d'emploi fourni
- Une synchronisation du moteur imprécise ou raté entraîne l'endommagement des vannes



APPLICATION

OPEL	Astra-J	1.6 CDTi ecoFLEX	LVL/B16DTH	2013 - 2017
	Astra-J	1.6 CDTi ecoFLEX	LVL/B16DTH	2013 - 2017
	Astra-J	1.6 CDTi ecoFLEX	LVM/B16DTL	2013 - 2017
	Astra-K	1.6 CDTi	LVL/B16DTH	2015 - 2017
	Astra-K	1.6 CDTi	LWQ/B16DTC	2015 - 2017
	Astra-K	1.6 CDTi	LWQ/B16DTE	2015 - 2017
	GTC	1.6 CDTi ecoFLEX	LVL/B16DTH	2015 - 2017
	GTC	1.6 CDTi ecoFLEX	LVL/B16DTH	2015 - 2017
	Insignia	1.6 CDTi	LVL/B16DTH	2015 - 2017
	Insignia	1.6 CDTi	LVL/B16DTJ	2015 - 2017
	Meriva-B	1.6 CDTi	LVL/B16DTH	2013 - 2017
	Meriva-B	1.6 CDTi	LVL/B16DTN	2013 - 2017

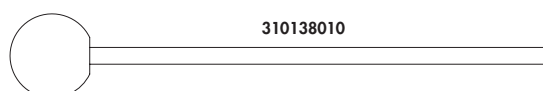
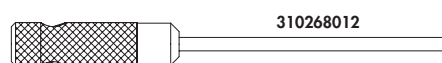
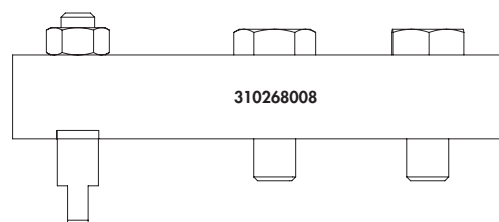
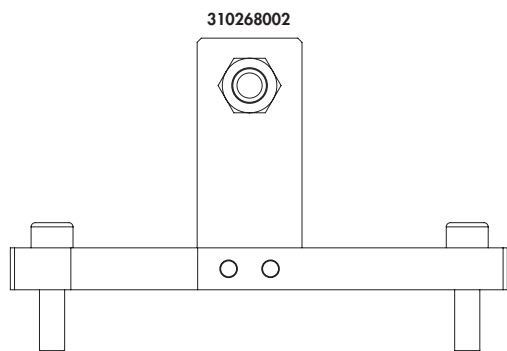
Code moteur	Code OEM				
	EN-51188	EN-50513	EN-51140	EN-51143	EN-6349 – EN-6130
LVL/B16DTH	•	•	•	•	•
LVM/B16DTL	•	•	•	•	•
LVL/B16DTH	•	•	•	•	•
LWQ/B16DTC	•	•	•	•	•
LWQ/B16DTE	•	•	•	•	•
LVL/B16DTJ	•	•	•	•	•
LVL/B16DTN	•	•	•	•	•
LVM/B16DTC	•	•	•	•	•
LVM/B16DTL	•	•	•	•	•
LWQ/B16DTE	•	•	•	•	•
LVL/B16DTN	•	•	•	•	•
LVL/B16DTJ	•	•	•	•	•

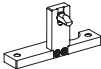

Components

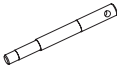
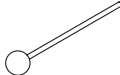
310268002	EN-51188	CAMSHAFT SPROCKET HOLDING TOOL WITH FIXINGS	
310268012	EN-50513	TENSIONER PIN	
310268008	EN-51140	CRANKSHAFT ALIGNMENT TOOL WITH FIXINGS	
310268011	EN-51143	CAMSHAFT SETTING PIN	
310138010	EN-6349 – EN-6130	BALANCER SHAFT LOCKING PIN	

SAFETY PRECAUTIONS - PLEASE READ

- **Use protective work gloves, protective footwear, hard hat and safety goggles**

- **Misuse:**

This product should only be used as described in this documentation; any other use is considered improper. The manufacturer accepts no responsibility for any damage caused by the incorrect or unreasonable use of the equipment; Moreover, misuse shall also void the warranty.

- **Take care of your tools:**

Be sure to store your tools in a clean state. Place the tools inside their original package.

- Disconnect the battery earth leads (check radio code is available)
- Remove spark or glow plugs to make the engine turn easier
- Do not use cleaning fluids on belts, sprockets or rollers
- Always make a note of the route of the auxiliary drive belt before removal
- Turn the engine in the normal direction (clockwise unless stated otherwise)
- Do not turn the camshaft, crankshaft or diesel injection pump once the timing chain has been removed (unless specifically stated)

- Do not use the timing chain to lock the engine when slackening or tightening crankshaft pulley bolts
- Do not turn the crankshaft or camshaft when the timing belt/chain has been removed
- Mark the direction of the chain before removing
- It is always recommended to turn the engine slowly, by hand and to re-check the camshaft and crankshaft timing positions
- Crankshafts and Camshafts may only be turned with the chain drive mechanism fully installed
- Do not turn crankshaft via camshaft or other gears
- Check the diesel injection pump timing after replacing the chain
- Observe all tightening torques
- Always refer to the vehicle manufacturer's service manual or a suitable proprietary instruction book
- Incorrect or out of phase engine timing can result in damage to the valves
- It is always recommended to turn the engine slowly, by hand, and to re-check the camshaft and crankshaft timing positions

APPLICATION

OPEL	Astra-J	1.6 CDTi ecoFLEX	LVL/B16DTH	2013 - 2017
	Astra-J	1.6 CDTi ecoFLEX	LVL/B16DTH	2013 - 2017
	Astra-J	1.6 CDTi ecoFLEX	LVM/B16DTL	2013 - 2017
	Astra-K	1.6 CDTi	LVL/B16DTH	2015 - 2017
	Astra-K	1.6 CDTi	LWQ/B16DTC	2015 - 2017
	Astra-K	1.6 CDTi	LWQ/B16DTE	2015 - 2017
	GTC	1.6 CDTi ecoFLEX	LVL/B16DTH	2015 - 2017
	GTC	1.6 CDTi ecoFLEX	LVL/B16DTH	2015 - 2017
	Insignia	1.6 CDTi	LVL/B16DTH	2015 - 2017
	Insignia	1.6 CDTi	LVL/B16DTJ	2015 - 2017
	Meriva-B	1.6 CDTi	LVL/B16DTH	2013 - 2017
	Meriva-B	1.6 CDTi	LVL/B16DTN	2013 - 2017

Engine code	OEM code				
	EN-51188	EN-50513	EN-51140	EN-51143	EN-6349 – EN-6130
LVL/B16DTH	•	•	•	•	•
LVM/B16DTL	•	•	•	•	•
LVL/B16DTH	•	•	•	•	•
LWQ/B16DTC	•	•	•	•	•
LWQ/B16DTE	•	•	•	•	•
LVL/B16DTJ	•	•	•	•	•
LVL/B16DTN	•	•	•	•	•
LVM/B16DTC	•	•	•	•	•
LVM/B16DTL	•	•	•	•	•
LWQ/B16DTE	•	•	•	•	•
LVL/B16DTN	•	•	•	•	•
LVL/B16DTJ	•	•	•	•	•



MECCANOCAR ITALIA S.r.l.

Via Malta 2/1 - 16121 Genova - ITALY
Tel. + 39 0587 609433 | Fax + 39 0587 607145
mec@meccanocar.it | www.meccanocar.it