

Pormenor de posicionamento do conector de 11mm

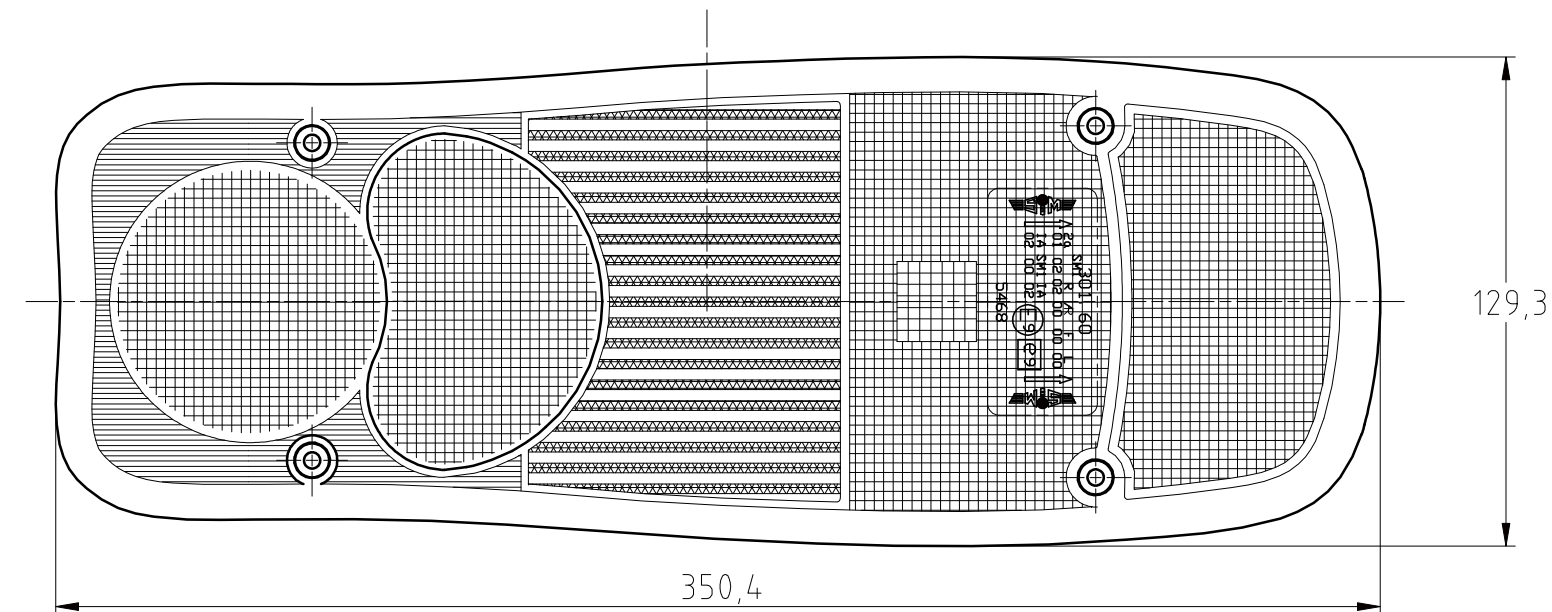
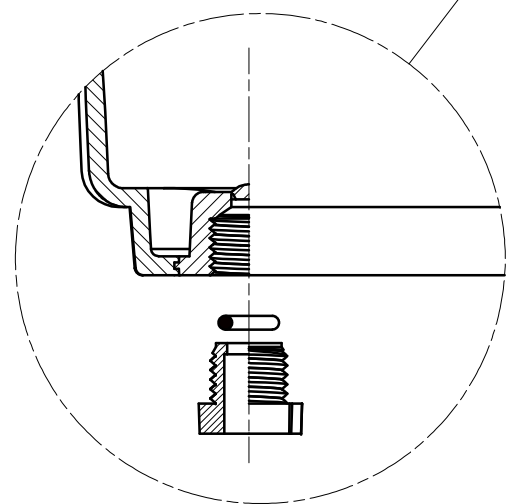

7.301.60.0113

Kit de acabamento 5x25x16 inox c/ cordão de mousse Triâ.

7.301.60.0012

Cordão de mousse c\ 845mm

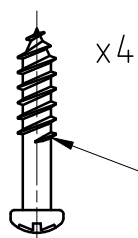
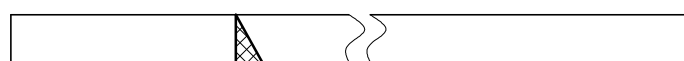

3.01.62.525.14 _ Parafuso AGL 5x25x16

C.Q. PH Inox

A	DESCRICAO	ALTEROU	DATA
EDICAO	REVISIONS	REV. BY	DATE

 SOCIEDADE IRMAOS MIRANDA SA		BORRALHA - APARTADO 8 3750 AGUEDA PORTUGAL		TEL Nº +351 234 61 08 60 FAX Nº +351 234 60 19 07						
ESC. (SCALE)	DESENHO (DRAWN)	DATA (DATE)	TITULO (TITLE)							
1:2	Tiago M.	09/11/09	1.3160.0000300 Farolim Dir. DIN Post.							
FER./MOL. (TOOL/MOULD)	VERIFICOU (CHECKED)	DATA (DATE)								
MATERIAL (MATERIAL)			COTAS SEM INDICACAO DE TOLERANCIA CONFORME DIN 7168 MEDIO							
ACABAMENTO (FINISH)			DE	3.00	6.00	30.00	120.00	315.00	1000.00	COPIA (COPY)
			ATE	±0.10	±0.20	±0.30	±0.50	±0.80	Nº	
			TOL.							

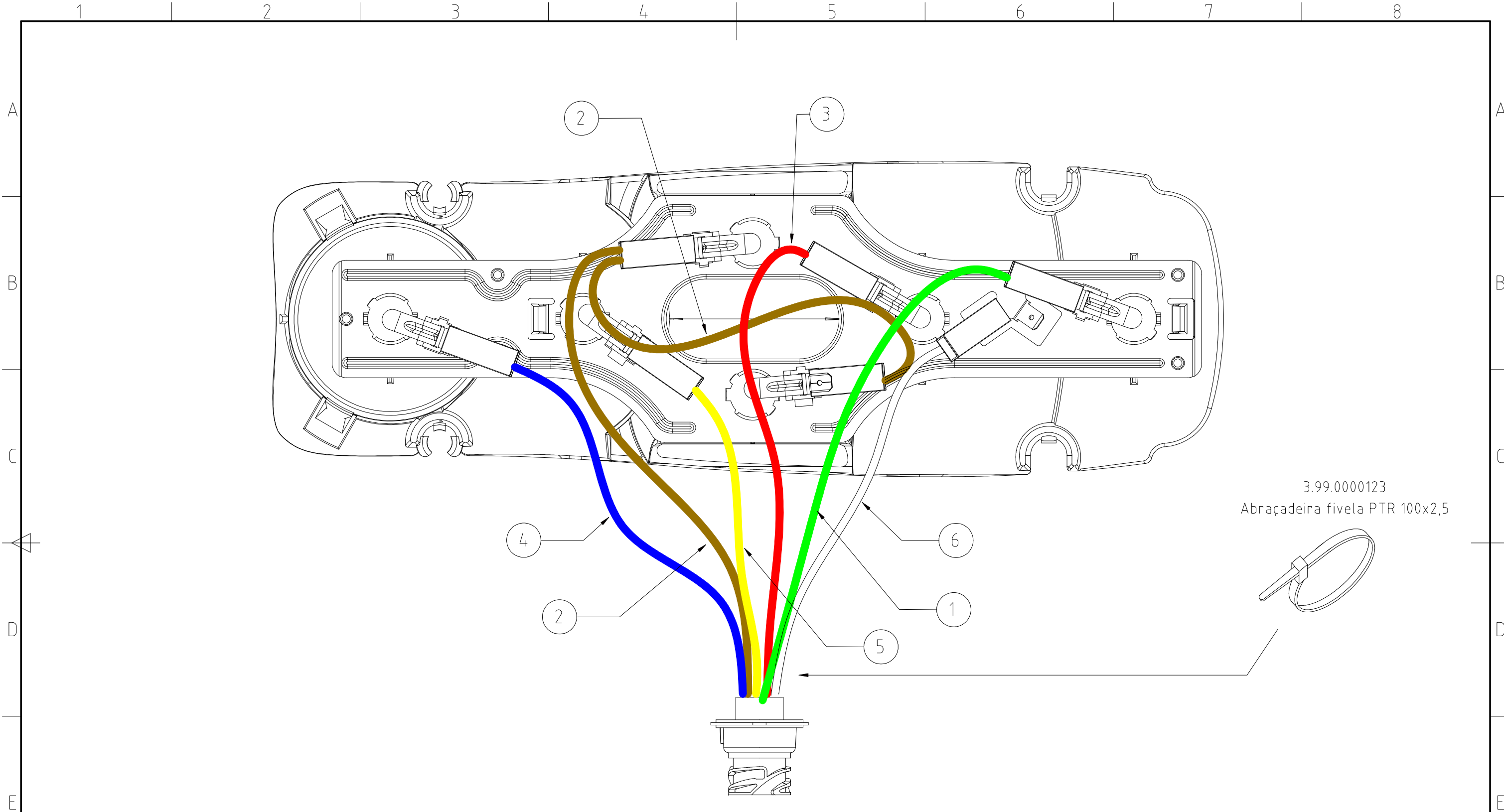

- 1 - 7.40.1.07.00902_ Fio verde c/160mm 1 terminal F e 1 terminal M DIN (PISCA - Pos. 4)
- 2 - 7.40.2.09.00902_ Fios cast. c/ 150 e 110mm 1 Term.F. e 1 Terminal M DIN (PRESENÇA - Pos. 2)
- 3 - 7.40.1.02.00902_ Fio verm. c/110mm 1 terminal F e 1 terminal M DIN (STOP - Pos. 5)
- 4 - 7.40.1.03.00902_ Fio azul c/160mm 1 terminal F e 1 terminal M DIN (NEVOEIRO - Pos. 6)
- 5 - 7.40.1.04.00902_ Fio amarelo c/110mm 1 terminal F e 1 terminal M DIN (MARCHA-ATRÁS - Pos. 3)
- 6 - 7.40.1.05.00902_ Fio branco c/150mm 1 terminal F e 1 terminal M DIN (MASSA - Pos. 1)

3.99.0000123
Abraçadeira fivela PTR 100x2,5

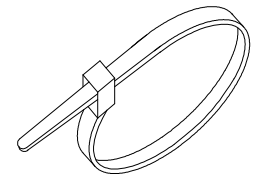

A	ALTER	LOCAL	DESCRICAO	ALTEROU	DATA
EDICAO	CHANGE	PART	REVISIONS	REV. BY	DATE



SOCIEDADE IRMAOS MIRANDA SA

BORRALHA - APARTADO 8
3750 AGUEDA
PORTUGAL

TEL Nº +351 234 61 08 60
FAX Nº +351 234 60 19 07

ESC. (SCALE)	DESENHO (DRAWN)	DATA (DATE)	TITULO (TITLE)				
1:2	Tiago M.	20/07/09	7.3160.0000332				
FER./MOL. (TOOL/MOULD)	VERIFICOU (CHECKED)	DATA (DATE)	Base dir. DIN posterior s/ janela c/ espelho				
PROPRIEDADE e CONFIDENCIALIDADE A informação contida neste desenho é propriedade de SIM-SA_Sociedade Irmãos Miranda. Qualquer reprodução em parte ou no seu todo sem a permissão de SIM-SA_Sociedade Irmãos Miranda é proibida.							
COTAS SEM INDICACAO DE TOLERANCIA CONFORME DIN 7168 MEDIO							
DE	0.50	3.00	6.00	30.00	120.00	315.00	A3
ATE	3.00	6.00	30.00	120.00	315.00	1000.00	
TOL.	±0.10	±0.10	±0.20	±0.30	±0.50	±0.80	